



# 7/11/22KW Smart EV AC Charger FEV-S/Txx

User's Manual

Flexible

Efficient

Smart

## Statements

Ensure that the product is installed in environments as specified in this manual. Incorrect installation could potentially damage the charger. Any resulting damage, personal injury or property damage is excluded from the warranty.

The company shall not be held liable for any consequences caused by the violation of these general safety requirements, design, production or safety standards.

The manual is for reference only and does not constitute a warranty of any kind. The actual product (including but not limited to color, size, and functions) may vary. If this manual is inconsistent with the description on the official website, the latter prevails.

Some functions may be subject to change, according to the charger's latest software and APP updates.

## Safety Information

- ◆ Before installing or cleaning the product, switch off the upstream residual current operated circuit-break-ers with integral overcurrent protection (RCBO) of it.
- ◆ Do not use or replace the product in extreme weather conditions.
- ◆ Do not remove the safety marks, warning signs, nameplates, or cabling marks from the product.
- ◆ Keep children away from the product.
- ◆ Do not insert your fingers or sharp objects into any components of the product.
- ◆ Do not use third-party cables or adapters.
- ◆ Do not disassemble, repair, or modify the product by yourself.



**Warning**



The input voltage and output voltage of device are dangerous high voltage. Touching high voltage will endanger human life. Before attempting to install or operate device, carefully read this manual and pay attention to all warning signs in the device. Only authorized professionals are allowed to install or dismantle this device.

### FLEXIBLE OPTION

- Multiple startup charging methods
- Wall-mount or floor stand installation
- The length of the charging cable can be flexibly selected/customized to any length (5 meters standard)

### HIGH TEXTURE DESIGN

- Multi colors front cover optional
- Support color customization
- Multi colors indicator light
- Optional design for display screens

### RELIABLE AND SAFETY

- Complies with relevant IEC standards
- Requires an external, certified type B RCD

# Contents

<b>Chapter 1 Product introduction .....</b>	<b>1</b>
1.1 Production introduction .....	1
1.2 Usage environment .....	2
1.3 Key features .....	3
1.4 Purchase list .....	3
1.5 Technical parameter .....	3
1.6 Packing list .....	4
1.7 Shipment and storage .....	4
<b>Chapter 2 Installation instructions .....</b>	<b>5</b>
2.1 Installation conditions .....	5
2.2 Installation risk notification .....	5
2.3 Installation guidance .....	5
2.3.1 Pedestal mounted and wall mounted installation guidance .....	5
2.3.2 Wall mounted plate and plug holder installation guidance .....	7
2.3.3 Install charger box .....	8
<b>Chapter 3 Operating instructions .....</b>	<b>11</b>
3.1 Inspection before power on .....	11
3.2 Indicator light meaning .....	11
3.3 Buzzing prompt instruction .....	11
3.4 APP operation instruction .....	12
3.4.1 User registration .....	12
3.4.2 EV charger binding with 4G .....	12
3.4.3 EV charger binding with Wi-Fi .....	13
3.4.4 EV charger charging .....	15
3.4.5 App interface description .....	17
3.4.6 Common issues resolution .....	19
<b>Chapter 4 Troubleshooting Common Faults .....</b>	<b>20</b>
Maintain record .....	21

# Chapter 1 Product Production

## 1.1 Production introduction

This product is a Smart EV AC Charger, which is a new vehicle charger system designed in accordance with the requirements of the latest relevant national standards such as **IEC 61851 and EN 61851**. The selection of each component and the safety protection performance fully meet the requirement of the standard.

This product integrates AC power switch, charging control unit, display, meter and communication, and realizes the smart control of the full charging process by connecting with the electric vehicle.

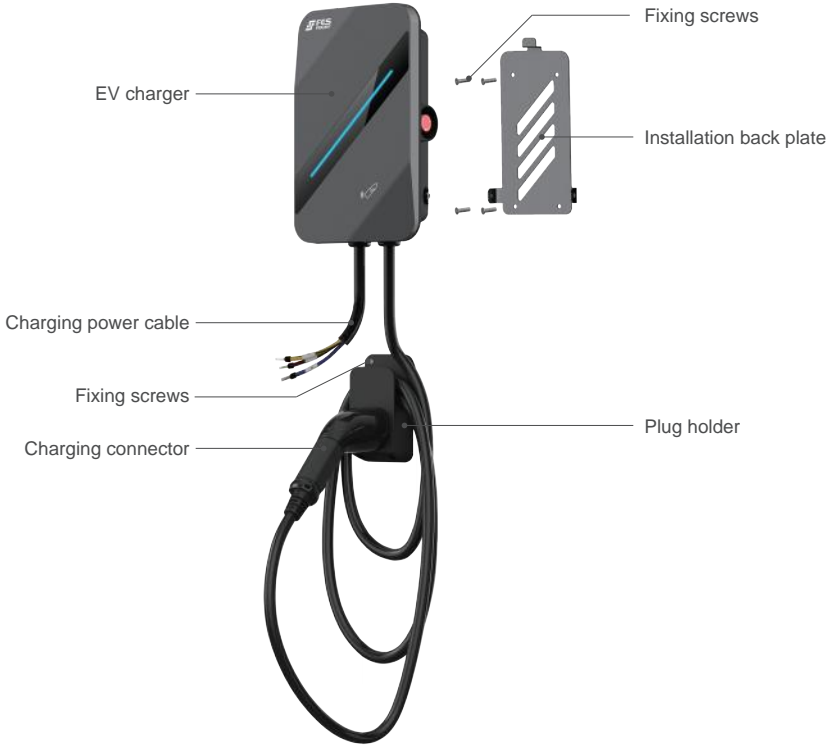

Product breakdown diagram



Pedestal mounted installation 1



Wall mounted installation 2

## 1.2 Usage environment

- (1) When installing, place the charger in a stable position, avoid direct sunlight, and the vertical tilt angle should not exceed 5°.
- (2) The installation place should be able to ensure that the equipment is protected from the possibility of strong vibration and shock.
- (3) Do not install the product in or near areas with flammable, explosive, chemical materials, or steam.
- (4) Keep a clean environment, no mould, avoid moisture, dust, water, flammable gases, flammable liquids, and keep away from heat sources and corrosive environment.
- (5) Keep a daily average relative humidity of  $\leq 95\%$ , monthly average relative humidity of  $\leq 90\%$ .
- (6) Operating temperature:  $-30^{\circ}\text{C} \sim 50^{\circ}\text{C}$ .
- (7) The altitude does not exceed 2000 meters.

### 1.3 Key features

- (1) This product has the function of control and protection, monitoring the full operation status to ensure the user charging safety.
- (2) APP, plug & charge, card swiping multiple start up method, charging operation is smart and simple.
- (3) Complete protection functions such as emergency stop, leakage, short circuit, etc., and high safety factor.
- (4) Adopt high-strength engineering plastic shell, good strength and impact resistance.
- (5) The appearance is fashionable and generous, with high recognition and good visual image.

### 1.4 Purchase list

Model No.	Description	Remark
FEV-S/Txx	FES Smart EV AC Charger	Standard
Pedestal	Pedestal(with back panel' fixing screws)	Optional

### 1.5 Technical parameter

Name	Parameter		
Input voltage	230V ± 20%	400V ± 20%	
Rated power / current	7KW / 32A	11KW / 16A	22KW / 32A
Frequency	50 / 60Hz		
Authorization	APP, Plug & charge, NFC card swiping		
Networking	Wi-Fi / 4G(Optional)		
Protection	over voltage, under voltage, over current, leakage current, short circus, emergency stop, ground, over temperature etc.		
Charger connector	type2		
Dimension	330 x 204 x 88mm (H x W x D)		
Weight	≤ 5.2kg	≤ 5.3kg	≤ 5.6kg
Installation	Wall mounted / Pedestal mounted		

\*Basic version just support NFC card swiping.

## 1.6 Packing list

Name	Parts name	Parts description	QTY
FES Smart EV AC Charger	Smart EV AC Charger	7/11/22KW AC charger	1 set
	Shipping accessories	User's Manual, Warranty card	1 pcs
		Certificate	1 pcs
		NFC card	2 pcs
		Installation back plate	1pcs
		Installation back plate fixed expansion tube kit: Φ8 expansion tube, M5 self-tapping screws	4 sets
		M4 Cross recessed pan head screw	2 pcs
		Charger plug	1 pcs
		Charger plug holder fixed expansion tube kit: Φ6 expansion tube; M4 self-tapping screws	4 sets
Pedestal (Optional)	Pedestal	Pedestal	1 set
	Install accessories	M5x12 Cross recessed pan head screw	4 pcs
		M4x14 Cross countersunk pan head screw	4 pcs
		D30 cable protection ring	1 pcs

## 1.7 Shipment and storage

- (1) The warehouse should be equipped with rodent-proof settings, should be dust-proof and moisture-proof to maintain a safe and suitable storage environment.
- (2) The transport vehicle should be clean, and the charger should be protected well during the transportation to prevent damage, the package carton can not be damaged, so as to avoid falling, impacting, and bumping.
- (3) Storage temperature: -40°C ~ 60°C.

## Chapter 2 Installation instructions

### 2.1 Installation conditions

- (1) The charger power is within the allowed load range of the residence.
- (2) The connected grounding system should be TN-S system, and meet the requirement of grounding resistance  $\leq 4\Omega$ .
- (3) The site selection, installation, and construction should comply with national laws, regulations and relevant standards. Professional installer and qualified construction unit should be selected.

### 2.2 Installation risk notification

- (1) The installation site should be avoided in a low-lying location that is prone to water accumulation, and should be kept at a safe distance from the surrounding fire and explosive facilities and underground pipelines, and the installation location should be far away from fire, high temperature, dust and corrosive environment, and the charger box protection degree should be suitable for the installation environment.
- (2) The strength of the installation position (wall and ground) must meet the requirement, all fixing bolts should be tightened, otherwise there will be a risk of falling and tipping.
- (3) The cables, terminals and other components used for installation should meet the current requirement, and all cables should be ensured to be wired after installation tightened, well-insulated, correct wired, no risk of wear and tear, otherwise there is a safety risk.
- (4) The power supply cable must be fixed to ensure that it is firm and reliable, prevent pulling, and avoid potential safety hazards.
- (5) After installation, ensure that all electrical components, protective box, insulation tubes, and other device are not lost, otherwise there is a safety risk.
- (6) Before powering on the equipment, please ensure that the charger is properly grounded.
- (7) If there is any damage on the charger, please stop installation and immediately.
- (8) After wiring, ensure that all holes entering the charger equipment are sealed properly, otherwise there is risk of cable ignition.

### 2.3 Installation guidance

#### 2.3.1 Pedestal mounted and wall mounted installation guidance

- (1) Produce a concrete base according to the construction and installation drawings, with a reserved length of input cables of  $\geq 1700\text{mm}$ (based on the concrete foundation).
- (2) Pedestal base is fixed with M8 expansion bolts, and 4 holes are drilled with a 10mm impact drill to install M8 expansion bolts, the embedded bolts should be perpendicular to the surface of the foundation.
- (3) The buried depth should be  $\geq 150\text{mm}$ , and the exposed length of the embedded bolts is recommended to between 15~30mm(maximum not exceeding 50mm of the base), it is strictly prohibited to use hexagonal bolts or screw rods instead. The pedestal base is fixed on the concrete base by M8 screws, flat washers and spring washers need be added when fixing, after fixing, bolts should be anti-corrosion treatment, such as applying butter or spraying silver powder.

(4) 7KW AC charger, power cables L, N, PE are connected to the power supply cable L, N, PE, 11KW/22KW AC charger, power cables L1, L2, L3, N, PE are connected to the power supply cable L1, L2, L3, N, PE, and waterproof must be done, After construction is completed, it is confirmed that the cables are not damaged and have been securely connected, and so on.

(Unit: mm)

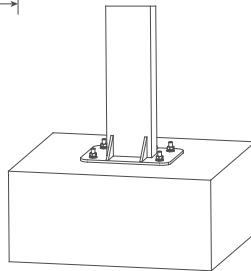
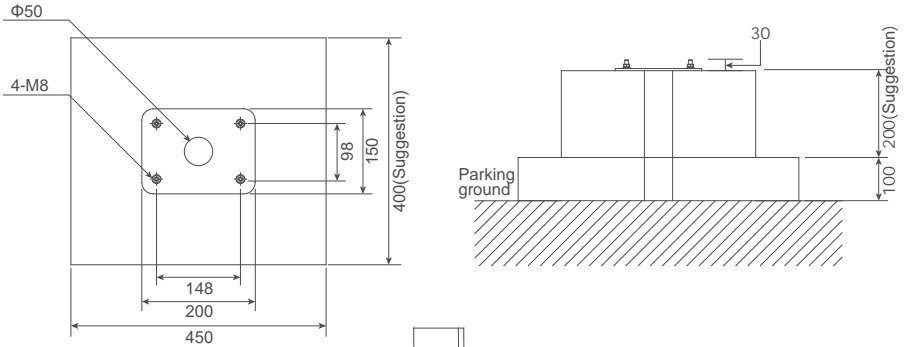

Pedestal installation diagram

(5) After pedestal installation is completed, fixed the back panel onto the pedestal tightly by M5x12 screws, the following diagram is for your reference:

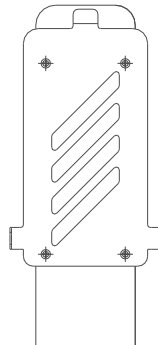

Wall mounted panels on pedestal installation diagram

(6) Fix plug holder on the pedestal by M4x14 cross countersunk pan head screw tightly, the following diagram is for your reference:

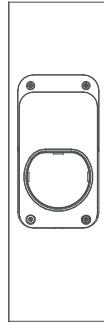

Plug holder on the pedestal installation diagram

## 2.3.2 Wall mounted plate and plug holder installation guidance

### 2.3.2.1 Wall mounted installation

- (1) First, you should locate the wall mounted plate. It is recommended back panel lower edge at a distance of 1250~1500mm from the ground, if the charger is installed near the edge of the wall, the distance between the back panel and the wall edge should be more than 500mm, and ensure that the wall in the area where the back panel is installed is clean and flat, otherwise it will cause deformation of the installation back panel and the charger can not be installed.
- (2) Then, drill 4 holes with a diameter of 8mm and a depth more than 60mm on the wall according to the position of the fixed holes on the installation back panel.
- (3) Install expansion pipe kit, insert the  $\Phi 8 \times 40$  expansion pipe tube into the drilled hole and tighten it.
- (4) Install the wall mounted panel, lock them with M5 self tapping screws from the expansion pipe kit.

### 2.3.2.2 Installation plug holder

- (1) First, you should locate the plug holder. It is recommended that the center of the charger plug be 850~1200mm, and the center be kept vertical with the charger center.
- (2) Then, drill 4 holes with a diameter of 6mm and a depth more than 60mm on the wall according to the fixed hole position of the charger plug.
- (3) Install expansion pipe kit, insert the  $\Phi 6 \times 40$  expansion pipe tube into the drilled hole and tighten it.
- (4) Fix and tighten the charger plug with M4 self tapping thread from the expansion tube kit.

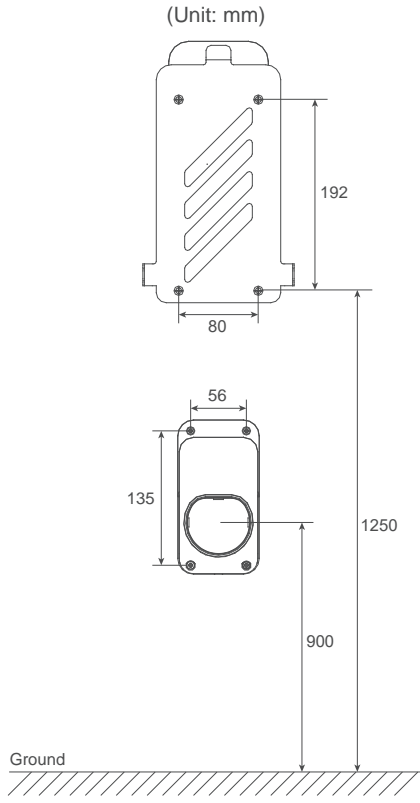

Wall mounted plate and plug holder installation diagram

### 2.3.3 Install charger box

(1) After installing the wall mounted plate, hang the charger box and lock it from the side with 2pcs M4 screws.



Charger box locking on back plate diagram

(2) Fix the power cable harness to the corresponding terminal of the type B RCD according to the power cable identification, and connect the PE wire to the PE busbar.

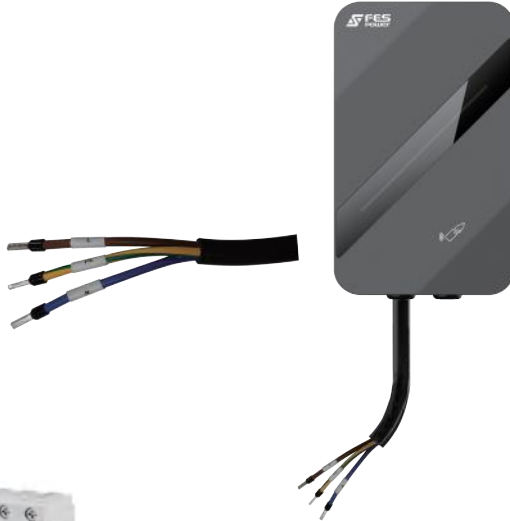

Cable harness diagram(1Ph)



FEV-S32



FEV-T16  
FEV-T32



Cable harness diagram(3Ph)

Note: This product requires an external type B RCD that meets certification requirements during operation.

(3) Fix the power cable harness to the corresponding terminal of the product according to the power cable identification.

※Cable specification: 3-core or 5-core copper cable, with conductor cross-sectional area of 6 mm<sup>2</sup> and above.



Cable harness diagram  
FEV-S32(1Ph)



Cable harness diagram  
FEV-T16/32  
(1Ph Connection guide)



Cable harness diagram  
FEV-T16/32  
(3Ph Connection guide)

※When only single-phase power is available, follow the wiring diagram shown; otherwise, the device will not operate.

(4) After installation is completed, check whether the charging emergency stop switch has been pressed (If it has, please turn it right to reset it).

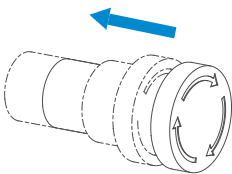

Emergency stop switch is  
pressed diagram

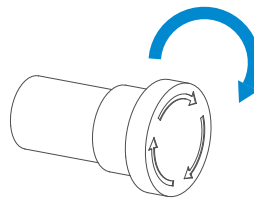

Emergency stop switch turn  
right diagram

## Chapter 3 Operating instructions

### 3.1 Inspection before power on

Checking sequence	Inspection content
1	Check the model of circuit breaker in front of distribution cabinet to ensure model reasonable(rated voltage should be $\geq 230\text{VAC}$ , rated current $\geq 40\text{A}$ , breaking capacity $\geq 6\text{KA}$ ).
2	Confirm that the voltage between N and PE is less than 5V.
3	Confirm that the charger AC input L, N or L1, L2, L3 and N are not reversed.
4	Close the circuit breaker of the distribution cabinet.
5	Charger power on, and finish a single self checking with 30s.
6	After power on and self-test, observe the status of LED indicator light: Indicator light: normal standby-blue light always on; Fault state-red light always on.

### 3.2 Indicator light meaning

LED indicator	Meaning
Blue light always on	Normal standby
Blue lights confluence	Unauthorized charging(CP9V normal pressure)
Green lights move back and forth	Charging connector is authorized, charging has not started yet
Green light progress bar (recycle)	Insert charging connector to start charging(CP6V PWM)
Green light always on	End charging
Red light flashing	Fault alarm
Red light always on	Emergency stop

### 3.3 Buzzing prompt instruction

After connecting charging connector to the EV, put the NFC card in the NFC reading area, and a “beep” will sound, the card recognition is successful and charging is started. Remove the card(If the card is not removed for a long time, it will be recognized again and stop charging). After charging successfully, put the NFC card in the NFC reading area again, a “beep” will sound, the recognition is successful, and the charging will stop.

Buzzing prompt	Action	Action
One “beep”	NFC card reconigized	Start / End charging successfully

### 3.4 APP operation instruction

#### 3.4.1 User registration

Search for “FES ENERGY” in Google Play / Apple App Store, download and install it, the user registration process is as follows:

- (1) Click “Register” on the APP.
- (2) Enter the registration interface, fill in your username and password, check "Privacy Policy" and "User Agreement", and then select the “Privacy Policy” option.
- (3) Click the “Submit” button to complete the registration.

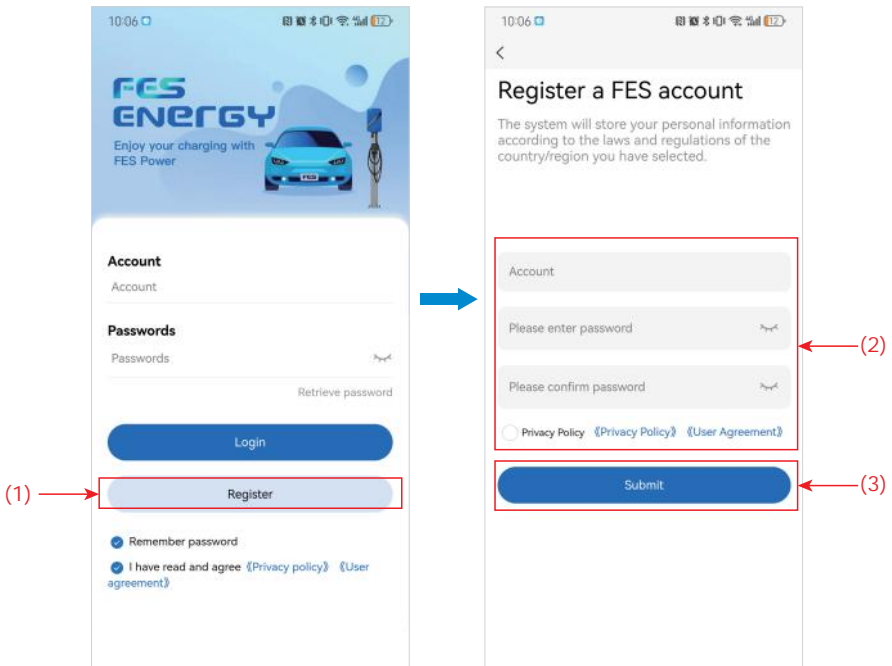

User registration process diagram

#### 3.4.2 EV charger binding with 4G

- (1) When use it for the first time, it is necessary to bind the charger.
- (2) Click “Add device” to enter the “Add device” interface.
- (3) Scan the QR code or input the device’s unique code, the QR code label is on the device back or the first page of manual.
- (4) After scanning the QR code, the device will be added automatically to the device list on the homepage, if it is not added successfully, please try adding it manually.

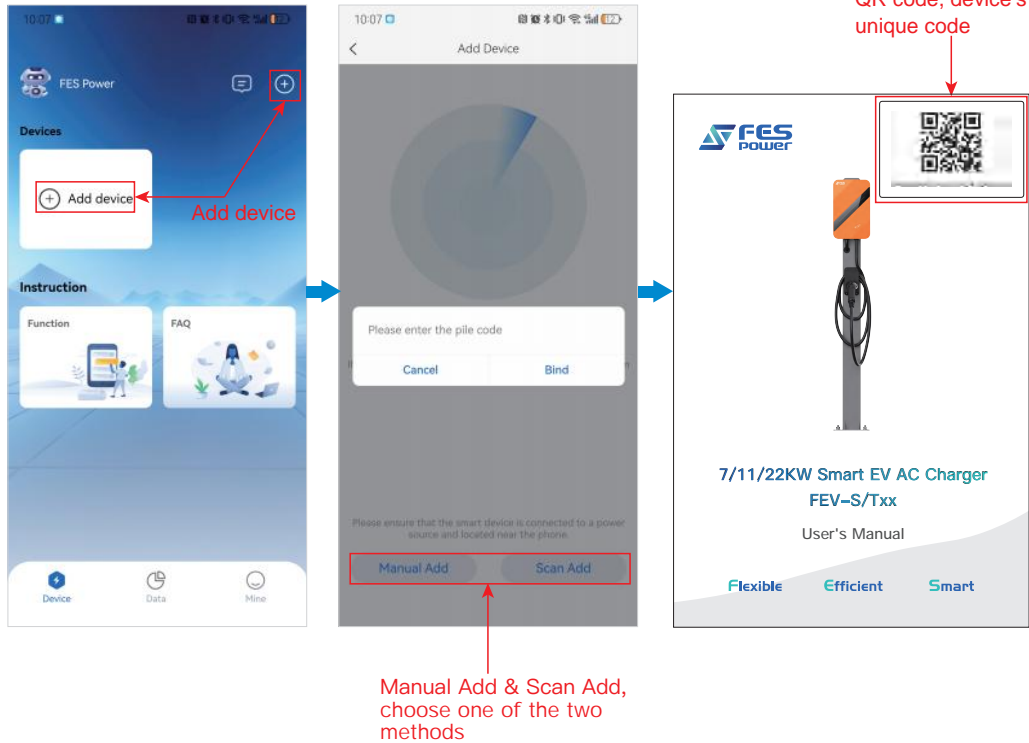

Charger binding process diagram(4G)

### 3.4.3 EV charger binding with Wi-Fi

- (1) When using it for the first time, the device needs to be connected to the network, turn on bluetooth and open APP, click "Add device" and scan the device, select your device to connect the network and bind it.
  - (2) Enter the name and password of Wi-Fi / Mobile hotspot in the distribution network interface, click "Next Step" to enter the data transmission status.
  - (3) After the network distribution is completed, the device interface will display that the charger has been bound successfully, otherwise it will not be successful.
- If your device has been connected to network, you can also add it by "Manual Add" or "Scan Add".

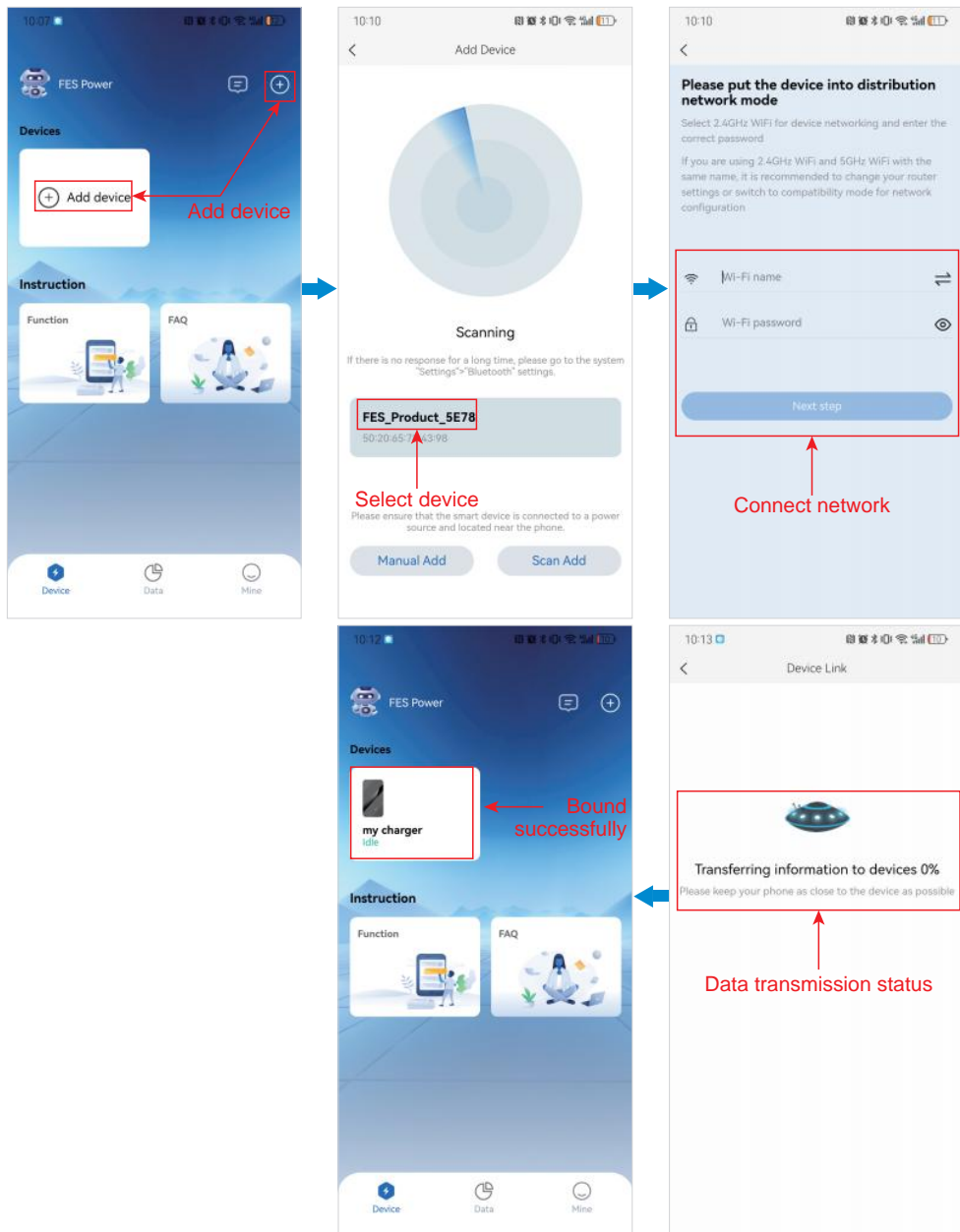

Charger binding process diagram(Wi-Fi)

## 3.4.4 EV charger charging

- (1) Click the device to enter the charging control details.
- (2) Insert the charging connector into the EV charging port, ensuring that the charging plug connect the EV properly.
- (3) Drag the “Swipe to charge” slider to charge, if the charging plug is not inserted, a prompt will appear saying “Please insert the connector first”.
- (4) Drag the “Slide to end” slider to stop charging.
- (5) Click “Schedule Charging” to enter the reservation interface, where you can schedule a time or reserve the battery to charge the EV.
- (6) Click “Charging records” to view the usage record of the charger.
- (7) Click “Charge mode” to change the charging mode of the charger to “Normal / Plug&Charge”.



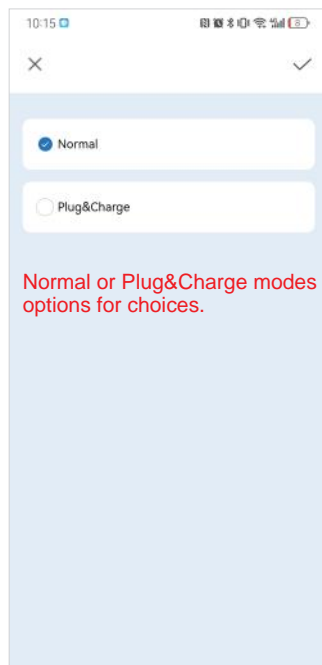
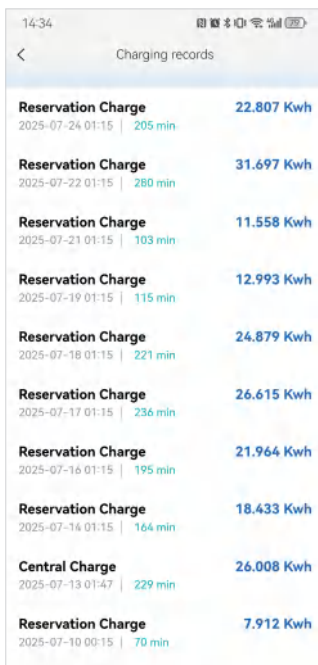
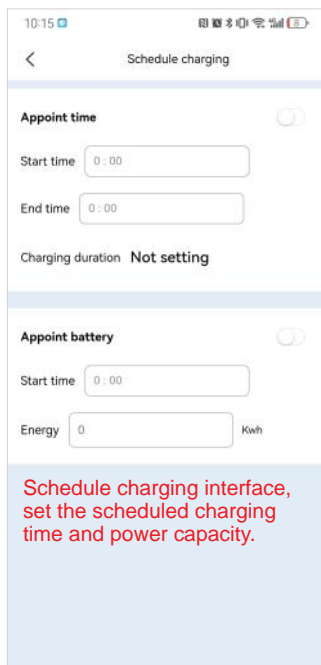

Charger usage process diagram

### 3.4.5 App interface description

- (1) The device interface allows for device selection, device addition, and common problems viewing, and so on.
- (2) The data interface is used to view the charger usage data.
- (3) "Mine" can change user nicknames and view additional information, click on setting to enter the setting interface.
- (4) Chinese and English version can be switched on the setting interface, and you can also view relevant information.



Device interface



Data interface

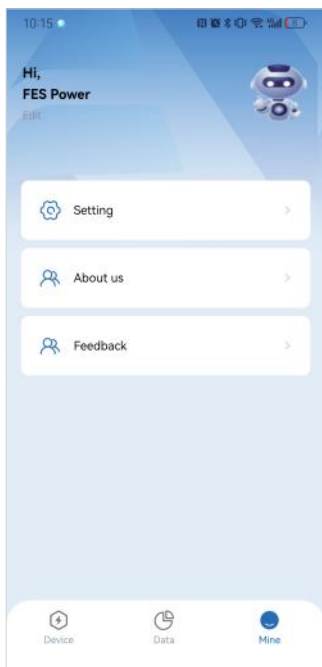

Mine

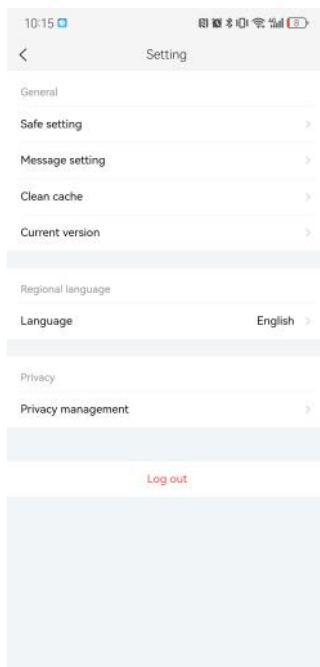

Setting interface

### 3.4.6 Common issues resolution

(1) After adding the device or configuring the network, the device still shows as offline for a long time.

Solution: Check if the device is connected to the network. Click "Add Device" and enter the "Add Device" interface. If the device's Bluetooth name is displayed, it means the device is not connected to the network. Please reconfigure the network for the device. If the Bluetooth name disappears in the "Add Device" interface, it indicates a successful network connection. Otherwise, the network connection is failed.

Notes:

The Wi-Fi frequency band should be 2.4G. If it is not 2.4G, the device will not be able to connect. If the Wi-Fi password is entered incorrectly, the device will not be able to connect.

After the configuration is completed and the device is successfully added, the device will update to the online status after a few seconds. If the device still shows "offline" after being added, please repeat the above steps to check if the Bluetooth name of the device still exists. If it does exist, you need to reconfigure it.

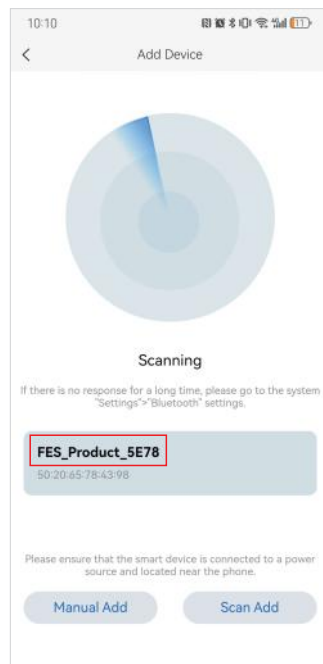

(2) The device loses power during charging

Solution: If you encounter a situation where the device suddenly stops charging and the light goes out during charging, please check if the leakage protection device at the input end is overheating and if the input cable is hot. The device requires that the rated current of the leakage protection device be at least 40A, and the input cable should use copper core wire with a diameter of no less than 6 square (aluminum wire is not allowed).

## Chapter 4 Troubleshooting Common Faults



### Warning

Violating operations in a faulty state may result in personal injury and equipment system damage!

◆ All operations described in this chapter must be carried out by trained professionals. The operator must be familiar with all the contents of this chapter.

◆ When operating the charger, all safety instructions in this manual must be followed.

◆ When the error can not be resolved by referring to this manual, please contact local distributor.

If an error occurs during operation, the charger system will stop running automatically, the fault light will light up, and the corresponding fault information will be displayed on the LED indicator.

### AC charger faults and solution methods

No.	Faults	Phenomenon	Solution
1	Network broken /DTU offline	APP display	Restart the router or device.
2	Emergency stop	Red light always on	1. Check whether the charging emergency stop switch has been pressed. If it has, please turn it right to reset it. 2. If the emergency stop button has not been pressed and still shows an emergency stop fault, please contact local distributor.
3	The indicator is off.	LED is off.	Check the upstream input power cable.
4	Over voltage, over current, Under voltage and other faults	Red light flashing	Disconnect the circuit breaker 3-5 minutes, then operate the charging process again after the fault is eliminated. If the fault persists after many time starts, please contact local distributor.
5	The charging connector can not remove.	The charging connector can not remove.	Please unlock the EV and remove the charging connector again.
6	The indicator is normal, but charging cannot be started.	The charging connector is not properly connected to the car.	Remove and replug the charging connector.





## Warranty Certificate

### Please keep the invoice & this certificate

Thank you for purchasing our product. We offer 1 year free warranty in accordance with the following term & conditions:

1. This certificate must be presented together with invoice for warranty service.
2. Free warranty does not include:
  - 2.1 Replacement and repair of cabinet and supplied accessories.
  - 2.2 Damage caused by accident, negligence, abuse or misuse improper.
  - 2.3 Normal wear & tear or any unauthorized repair or being tampered with.
3. This certificate will be void if altered.
4. By Mail:

Xiamen FES Power Technology Co., Ltd.

Add: N102 Weiye North Building, Xiamen Hi-Tech Innovation Center, Huli District, Xiamen,

Fujian, P. R. China

P.C.: 361015





APP Download QR code



FES Energy

IOS / Android



Xiamen FES Power Technology Co., Ltd.

---

+86-592-3699969

[lizj@fespower.cn](mailto:lizj@fespower.cn)

[www.fescharging.com](http://www.fescharging.com)

N102 Weiye North Building, Xiamen Hi-Tech Innovation Center, Huli District, Xiamen,  
Fujian, P. R. China

